

Strength

Made from Steel coated with highly Corrosion-resistant Zinc Alloy

Endurance

Finished with Double Oven-baked Epoxy Polyester Paints

Beauty

Available in Wood Finishes and Radiant Solid Colors!



An Achievement in Innovation

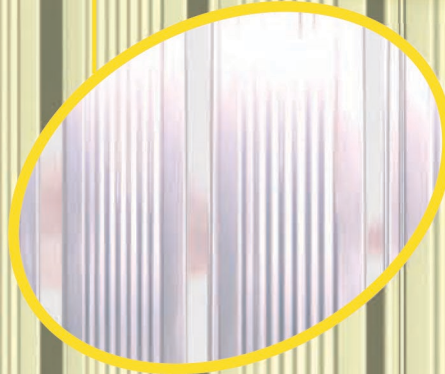

Base metal properties makes Cladstar highly resistant to all weathering conditions.



Special paint primers and finishing process makes Cladstar retain most of its properties throughout its service life, requiring very little or no maintenance.

Ideal for both interior and exterior applications

Your alternative for
facia, ceilings,
sidings, and
partitions, and
similar uses!

Architects and Designers choose

ALL PURPOSE SPANDREL

CLADSTAR®

the Perfect Building Alternative

Architects and Designers choose

ALL PURPOSE SPANDREL

CLADSTAR®

the Perfect Building Alternative

Installation:

For quality finished result of installation, ensure that the faces of all support/frame are in one plane. Spandrel can be used as ceiling (horizontal) and (vertical) including fascia. If end laps is necessary because of very long run, allow at least 25 mm lap.

Location of Fasteners:

The fasteners should be located at the side lap.

SP1 (MINI CORR)

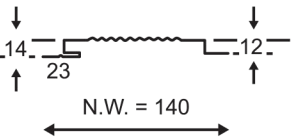
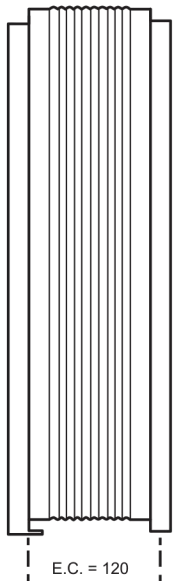

SP2 (RIBTYPE)

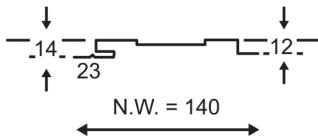
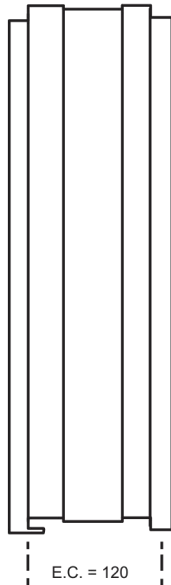

SP3 (V-TYPE)

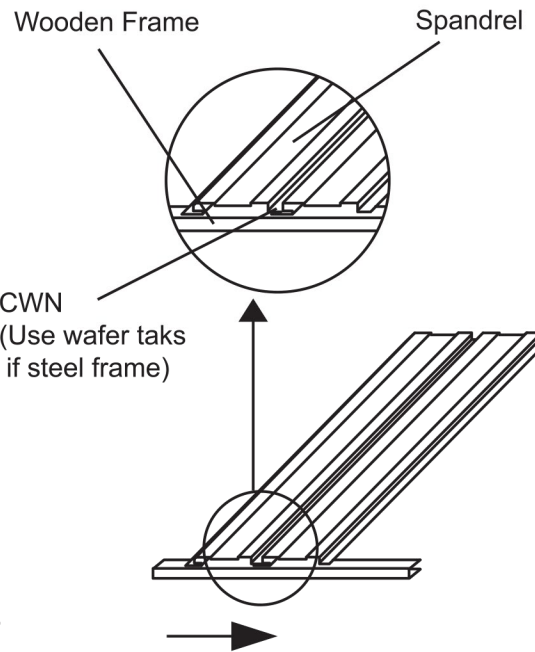
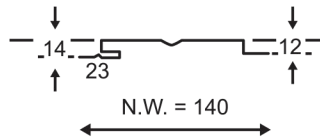
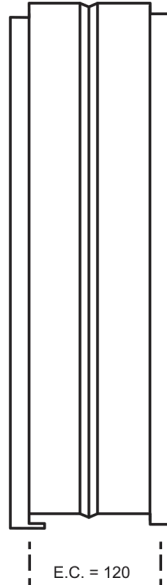

BENDED ACCESSORIES

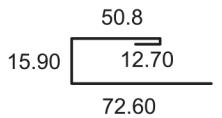

End or Corner Moulding

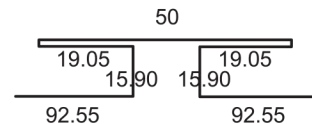

Connector Moulding

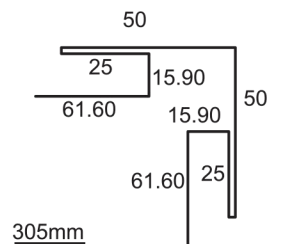

Exterior Moulding

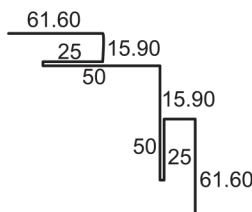

Interior Moulding

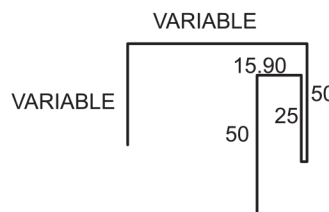

Upper Moulding

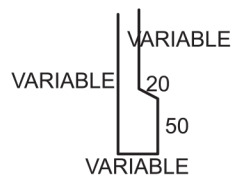

Lower Moulding